

Varenummer: 203160M850B2S
 Beskrivelse: E+G Justerfod
 GN 31-60-M8-50-B2-S
 Note: S Uden møtrik, udvendig sekskant i bunden

Mål

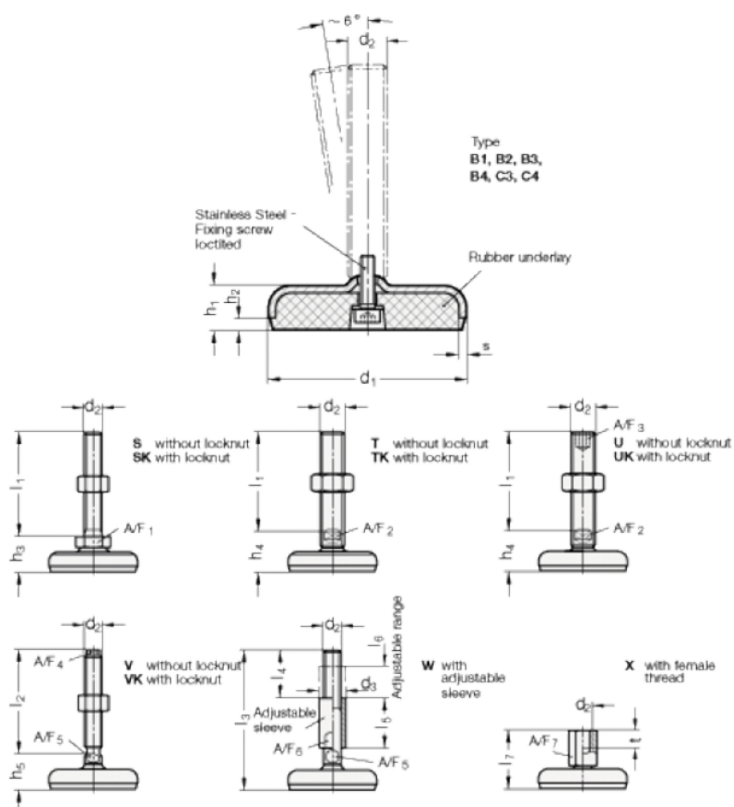

A/F1-	= 17
d1	= 60
d2	= 8
h1	= 16
h2	= 4
h3 +4.0/0	= 26
l1	= 50
s	= 3